

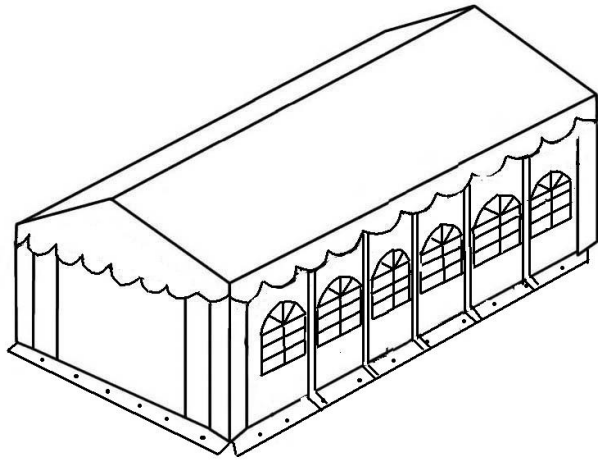

blumfeldt

Partyzelt



10029443 10029444

Sehr geehrter Kunde,

wir gratulieren Ihnen zum Erwerb Ihres Gerätes. Lesen Sie die folgenden Hinweise sorgfältig durch und befolgen Sie diese, um möglichen Schäden vorzubeugen. Für Schäden, die durch Missachtung der Hinweise und unsachgemäßen Gebrauch entstehen, übernehmen wir keine Haftung.

Artikelbeschreibung

Artikelnummer	
10029443	Partyzelt 6X12 m, PVC weiß
10029444	Partyzelt 6X12 m, PVC weiß, feuersicherer Stoff*











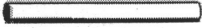
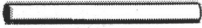
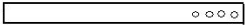

*feuersicher nach

DIN 4102-1 - B1
BS 7837:1996
BS 5438:1989 – Test Method 2B
CPAI-84:1995
NFP 92503 M2

Sicherheitshinweise

- Beachten Sie, dass das Zelt sorgfältig behandelt wird, um Beschädigungen zu vermeiden.
- Üben Sie auf das Gestänge keine Gewalt aus, da es dabei beschädigt werden kann.
- Die Zelte sind als vorübergehende Wohnstatt bestimmt und müssen bei extremen Wettersituationen evakuiert werden.
- Wählen Sie einen geeigneten Ort, wo Sie das Zelt aufschlagen. Vermeiden Sie damit Schäden an unterirdischen Sprinkleranlagen, Wasser-, Gas- und Stromleitungen.

Lieferumfang

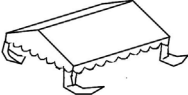
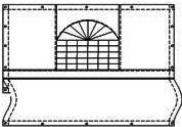
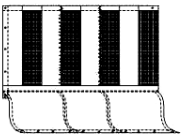
	Teil	Illustration	Stückzahl
1	Stange (1470 mm)		28
2	Stange (1940 mm)		48
3	Bein (1940 mm)		14
4	Stange (1920 mm)		14
5	Stange (1510 mm)		7
6	Eckverbinder (110°)		4
7	Mittelverbinder (110°)		10
8	Eckverbinder (140°)		2
9	Mittelverbinder (140°)		5
10	Kreuzverbinder		10
11	Seitenverbinder		4
12	Fuß, 3-Wege-Verbinder		4
13	Fuß, 3-Wege-Verbinder		10
14	Fuß, 2-Wege-Verbinder		4
	Dachplane		1
	Seitenplanen		12
	Türplanen		2

Aufbau

1. Legen Sie alle Verbinder und Stangen auf den Boden, wie in dem Bild unten. Stecken Sie alle Stangen in die Verbinder. Verwenden Sie die Schrauben, um sie festzuziehen.

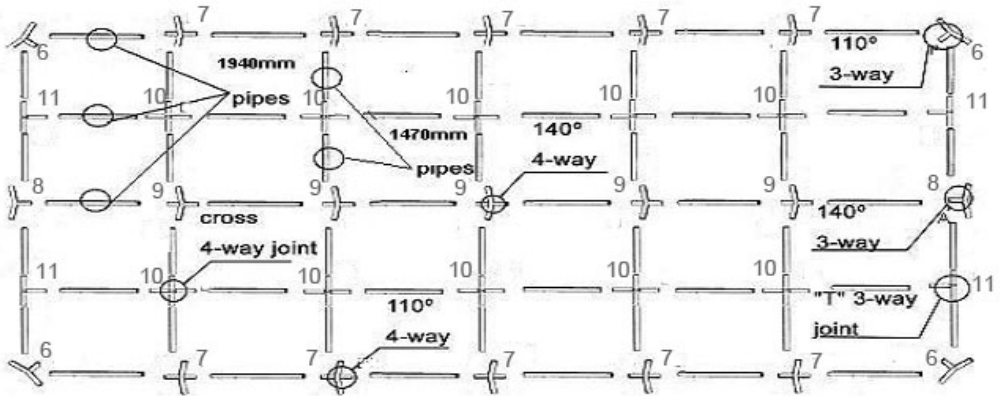

2. Verbinden Sie die Stangen. Beginnen Sie mit dem mittleren Rahmen. Setzen Sie anschließend die Seiten zusammen.

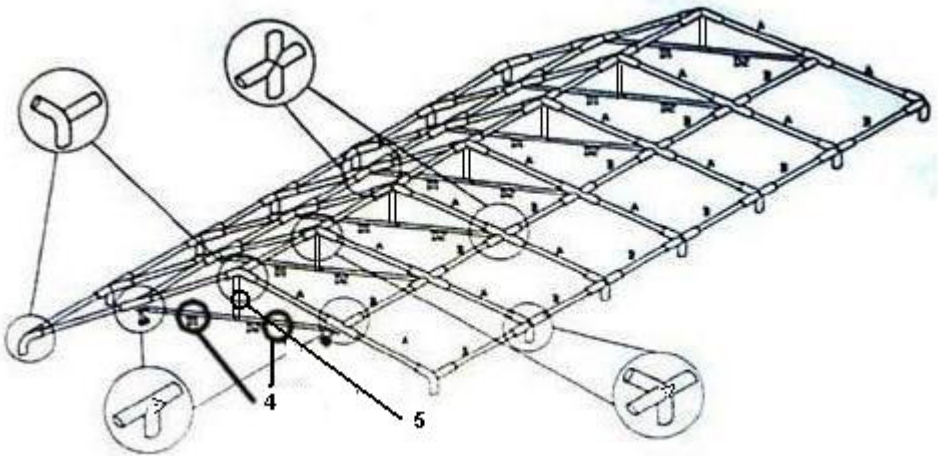

Anbringen der Zeltplane

1. Heben Sie den Rahmen an und setzen Sie die FüÙe an.
2. Ziehen Sie die Plane über den Rahmen.
3. Heben Sie die andere Seite des Rahmens an und stecken Sie die verbleibenden Beine hinein.
4. Befestigen Sie alle Seitenplanen und Türplanen.
Lösen Sie alle Schlaufen an den Beinenden, wenn Sie die Plane anbringen. Passen Sie die Festigkeit an, wenn das Dach aufgebaut ist.

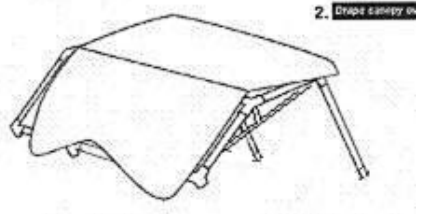
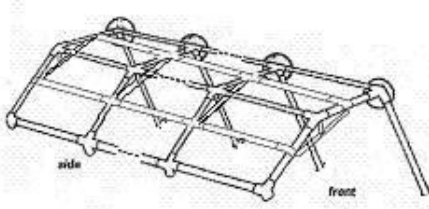

Befestigen Sie alle Seitenteile am Gerüst und setzen Sie die FüÙe an (12,13,14)

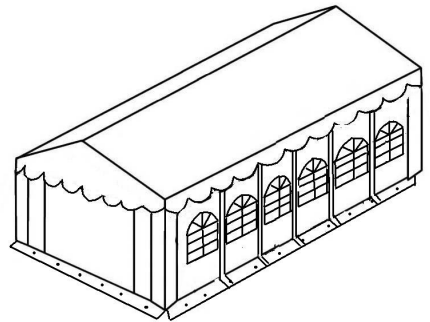
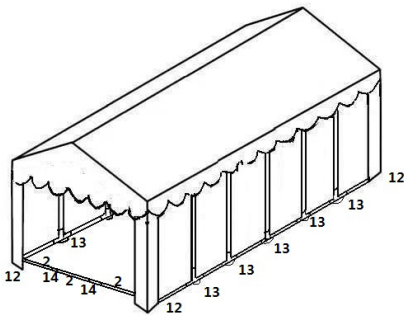

Hersteller: Chal-Tec GmbH, Wallstraße 16, 10179 Berlin, Deutschland

Dear Customer,

Congratulations on purchasing this equipment. Please read this manual carefully and take care of the following hints on installation and use to avoid technical damages. Any failure caused by ignoring the items and cautions mentioned in the operation and installation instructions are not covered by our warranty and any liability.

Product Description

Item number	
10029443	Party tent 6X12 m, PVC white
10029444	Party tent 6X12 m, PVC white, fire retardant fabric*













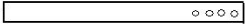

*fire retardant according to

DIN 4102-1 - B1
BS 7837:1996
BS 5438:1989 – Test Method 2B
CPAI-84:1995
NFP 92503 M2

Safety Instructions

- Take note that the tent needs to be handled carefully to avoid damage.
- Do not force the frame as they may be damaged in the process.
- Tents are meant as temporary shelter and must be evacuated under extreme weather conditions.
- Please select a suitable site for the tent to avoid the damage to underground sprinkler systems, water, gas or electrical lines.

Scope of Supply

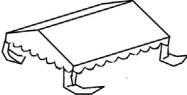
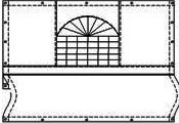
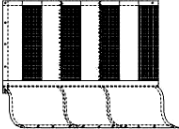
	Part	Illustration	Quantity
1	Pipes (1470 mm)		28
2	Pipes (1940 mm)		48
3	Legs (1940 mm)		14
4	Pipe (1920 mm)		14
5	Pipe (1510 mm)		7
6	3 way joints (110°)		4
7	4 way joints (110°)		10
8	3 way joints (140°)		2
9	4 way joints (140°)		5
10	Cross 4 way joints		10
11	3 way joints		4
12	3 way joints		4
13	3 Way joints		10
14	3 Way joints		4
	Roof cover		1
	Side panels		12
	Door panels		2

Assembling

1. Place all joints 1940mm pipes and 1470mm pipes on the ground as shown. Push two pipes into the joints, use screws fix them.

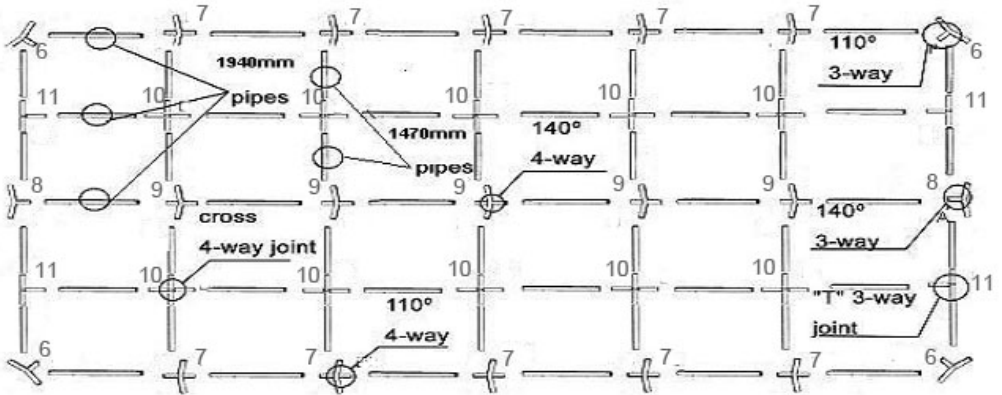

2. Connect pipes together starting with the centre frame. Then assemble each side.

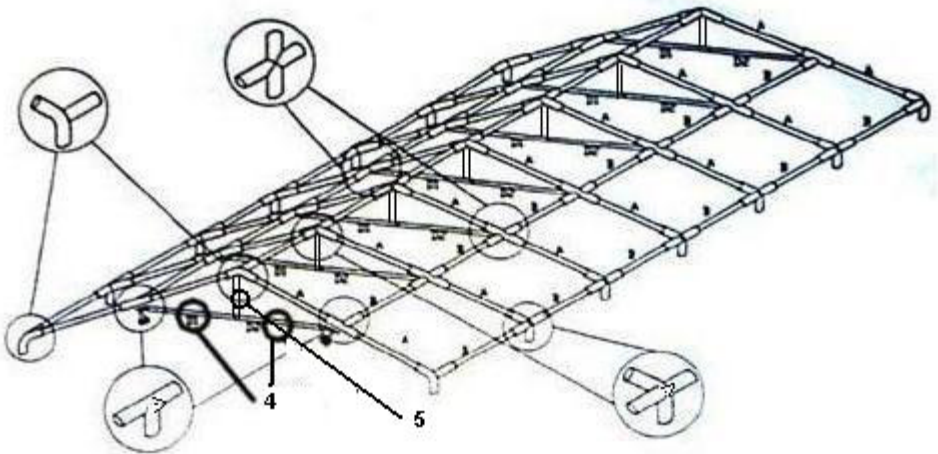

Attaching cover to frame

1. Start by lifting one of the frame and inserting legs.
2. Drape cover over frame.
3. Next, lift the other side of the frame and insert remaining legs.
4. Hung up the all side panels and door panels.

Loosen the straps on the bottom of the legs when attach the cover. Adjust as needed after the canopy is assembled.

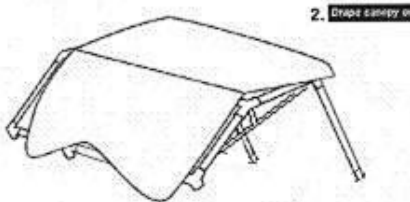
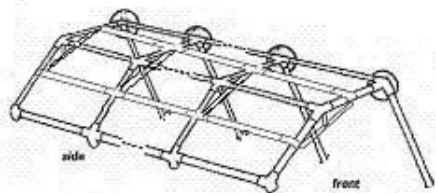

Then hang up the all side panels and set up the foot and the ground bar (12,13,14)

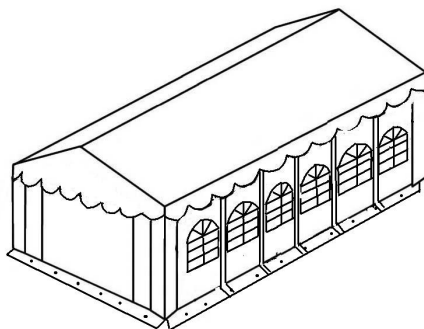
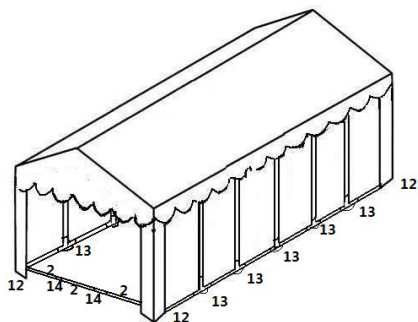

Producer: Chal-Tec GmbH, Wallstraße 16, 10179 Berlin, Germany